

LC-XD1217P*1

FOR STANDBY POWER SUPPLIES.
EXPECTED TRICKLE DESIGN LIFE: 10 - 12 YEARS
AT 20°C ACCORDING TO EUROBAT.

VdS
G104101

DIMENSIONS (MM)

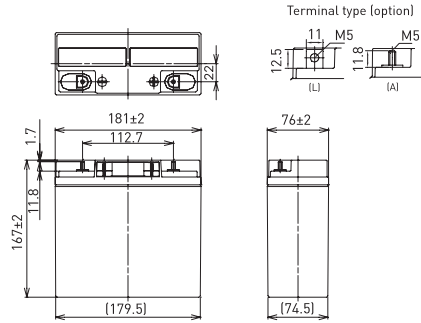

Battery case resin: standard (UL94 HB)

Contents indicated (including the recycle marking, etc.) are subject to change without notice.

SPECIFICATIONS	
Name	LC-XD1217PG/APG*1
Nominal voltage	12V
Nominal capacity (20 hour rate)	17Ah
Dimensions	Length 181mm
	Width 76mm
	Height 167mm
Approx. mass	5.900kg
Terminal	M5 bolt/nut & threaded post
Capacity (25°C)	20 hour rate 17Ah
	10 hour rate 16Ah
	3 hour rate 14Ah
	1 hour rate 12Ah
Impedance	Fully charged battery (25°C) 12mΩ
	40°C 102%
Temperature dependency of capacity (20 hour rate)	25°C 100%
	0°C 85%
	-15°C 65%
Self-discharge (25°C)	After 3 month 91%
	After 6 month 82%
	After 12 month 64%

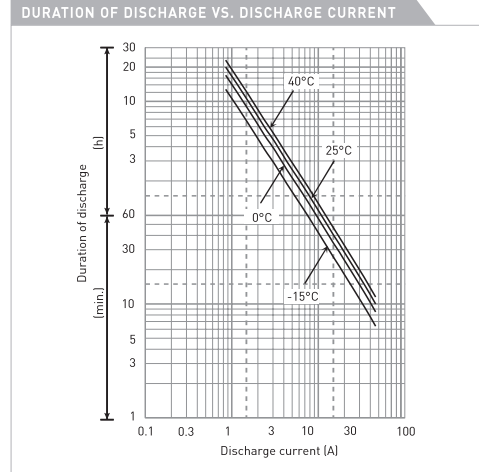

WATT TABLE (25°C)															[Wattage/battery]	
Cut-off	3min.	5min.	10min.	15min.	20min.	30min.	45min.	1h	1.5h	2h	3h	4h	5h	6h	10h	20h
9.6V	1,021	806	526	402	337	251	177	142	97.6	75.5	56.2	43.2	35.6	28.6	19.0	10.3
9.9V	948	756	516	399	331	249	176	140	95.6	74.9	55.9	42.9	35.4	28.5	18.9	10.3
10.2V	874	708	502	326	266	175	139	93.7	73.0	55.4	42.6	35.1	28.3	18.7	10.2	
10.5V	777	634	465	364	309	240	172	136	91.7	70.4	54.5	42.3	34.8	28.0	18.6	10.2
10.8V	656	561	415	339	301	232	169	134	89.2	67.1	53.4	41.8	33.9	27.5	18.4	10.1

AMPERE TABLE (25°C)															[Ampere/battery]	
Cut-off	3min.	5min.	10min.	15min.	20min.	30min.	45min.	1h	1.5h	2h	3h	4h	5h	6h	10h	20h
9.6V	91.8	72.2	47.0	34.9	29.0	21.5	15.1	12.0	8.26	6.37	4.72	3.61	2.97	2.39	1.58	0.86
9.9V	85.2	67.8	46.0	34.7	28.6	21.2	15.0	11.9	8.10	6.33	4.70	3.59	2.95	2.38	1.57	0.85
10.2V	78.6	63.5	44.9	34.0	28.1	21.0	14.9	11.7	7.93	6.16	4.65	3.57	2.93	2.36	1.56	0.85
10.5V	69.9	56.9	41.6	31.6	26.7	20.5	14.6	11.6	7.77	5.95	4.58	3.54	2.90	2.33	1.55	0.85
10.8V	59.0	50.3	37.1	29.5	26.0	19.8	14.4	11.3	7.56	5.67	4.49	3.49	2.83	2.29	1.53	0.85

All mentioned values are average values

LC-XD1217P*1

CHARGING METHOD (25°C)

Trickle use: Control voltage: 13.6V - 13.8V
Initial current: 2.55A or smaller

CUT-OFF VOLTAGE

Discharge current	0.850A - 3.40A	3.40A - 8.50A	8.50A - 17.0A	17.0A - 34.0A	34.0A - 51.0A
Cut-off voltage	10.5V	10.2V	9.9V	9.3V	8.7V

INFLUENCE OF TEMPERATURE ON TRICKLE LIFE

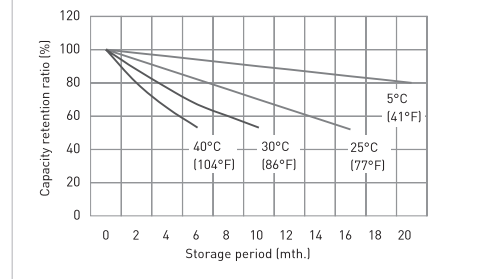
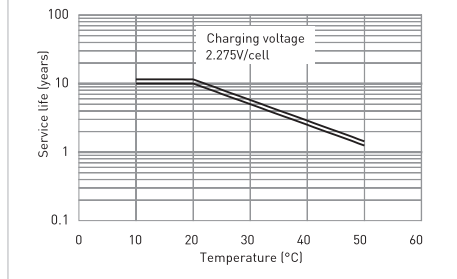

CONSTANT-VOLTAGE CONSTANT-CURRENT CHARGE CHARACTERISTICS FOR TRICKLE USE

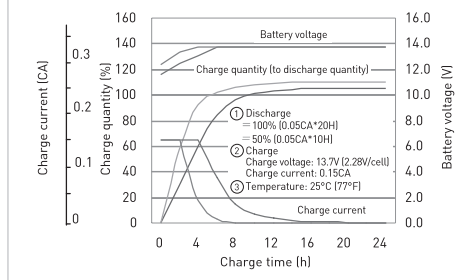

DISCHARGE CAPACITY BY TEMPERATURE AND BY DISCHARGE CURRENT

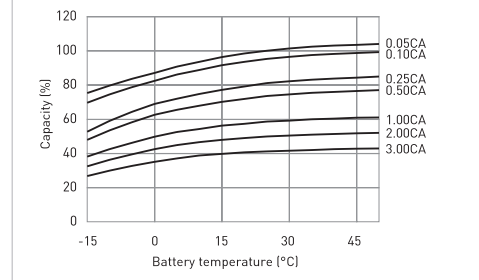

DISCHARGE CHARACTERISTICS

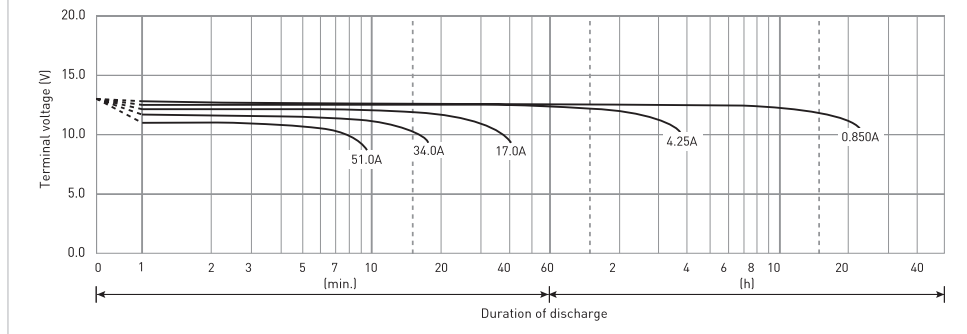

The data in this document are for descriptive purposes only and are not intended to make or imply any guarantee or warranty. Regarding handling and safety please consult our VRLA technical handbook chapter 1.